



D3568

Ology
Desking

Steelcase

Making the workplace a more health conscious environment

In any workplace, the bottom line is the health and wellbeing of its workers. A health conscious workplace protects the company's most significant investment and ensures the greatest productivity, efficiency, and innovation possible in the work environment.

Ology is the first desking solution that supports the physiology and biology of users to make the workplace a more health conscious environment.



Workplace wellbeing: a global challenge

Wellbeing is a dual challenge. Physical challenges, from back and neck pain to repetitive stress injuries and the long-term effects of sedentary workstyles, are just one part. Workers are also increasingly mobile, sharing desks, collaborating constantly and exposed to the millions of microbes on office worksurfaces.

Effects on user physiology and biology may result in increased absenteeism, decreased productivity, chronic disability and a decline in organizational performance.

A desking solution that addresses physiological and biological needs is a key business asset.

72%

of workers will be mobile by 2020¹.

25%

of workers in EU countries report back pain².

72%

of workers still report to work when sick³.

¹ International Data Corporation (IDC), 2015.

² European Foundation for the Improvement of Living and Working Conditions, 4th European Working Conditions Survey, 2007.

³ Lancaster University | Ellipse Insurance Group, 2012.

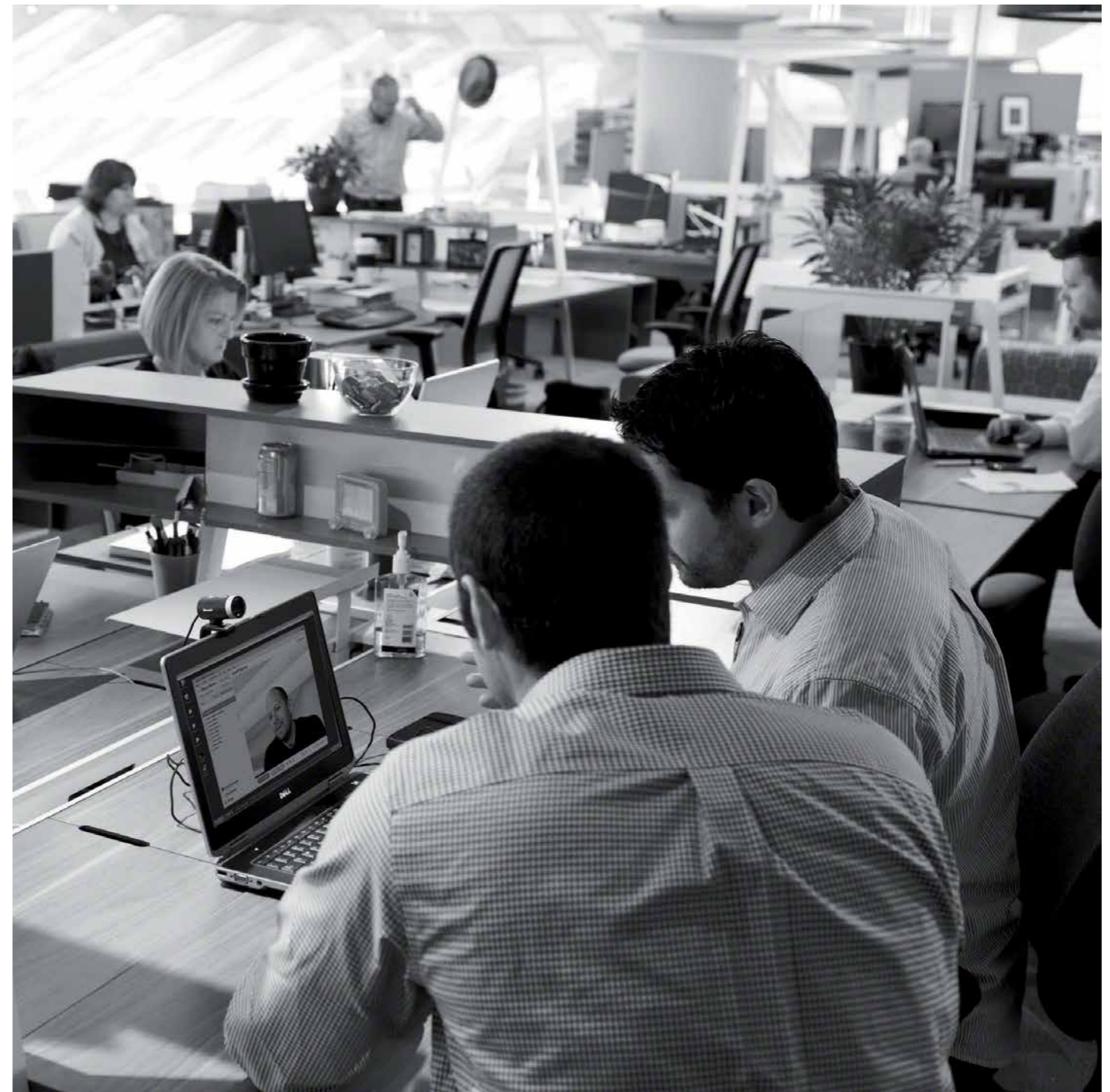

Improving the physiology of work

Ology makes it easy to change worksurface height and posture, and its convenient, intuitive controls encourage more health conscious behaviors. In addition, the soft edge profile reduces shoulder and neck fatigue during lengthy computer use.



D3610 | OLOGY DESK ELECTRIC (AT/ZW), PARTITO SCREEN (AT05), PLEASE TASK CHAIR (AT10), DASH MINI (WHITE)



D3338



D3611

5 HOURS 41 MINUTES

each day spent sitting at a desk.

*British Psychological Society conference,
January 15, 2012.*

Physiologic benefits of changing postures:

- increased energy level
- improved productivity
- reduced musculoskeletal discomfort
- decreased likelihood of weight gain and cardiovascular disease.

Learn more on the benefits of posture change visit www.steelcase.eu/ology

Simplifying collaboration

To accommodate impromptu stand-up meetings, Ology automatically adjusts with the touch of a button. Whether quickly touching base or engaging in a spur-of-the-moment brainstorming session, workers can be face-to-face in an instant, encouraging collaboration and movement throughout the day.



D3342

QUICK COLLABORATION

Quick, eye-to-eye collaborations are easy: when a colleague approaches, press the collaboration button and automatically Ology adjusts to a comfortable standing height.



D3340 | OLOGY BENCH ELECTRIC (ZW/AK), PARTITO SCREEN (AT17), SHARE IT STORAGE (WY/AK), MONITOR BRIDGE

Biology to benefit workplace wellbeing

Microbes populate the desktop, and 80% of infections can be transmitted by touch. Ology is available with proprietary BactiBlock®, a naturally sourced and highly efficient antimicrobial protection, molded into desk components.

This durable and long-lasting protection for the most frequently touched areas of the worksurface supports the wellbeing of each and every user of Ology desking for many years to come.

10 MILLION

germs on the typical desk.

Source: University of Arizona 2009.

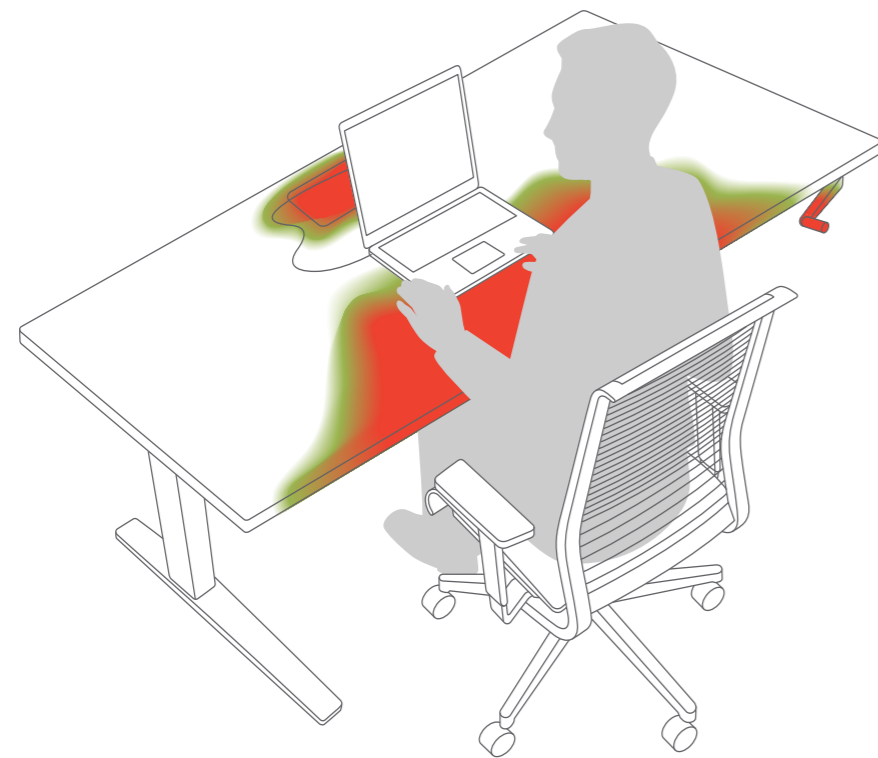

 Most frequently touched points on a workstation

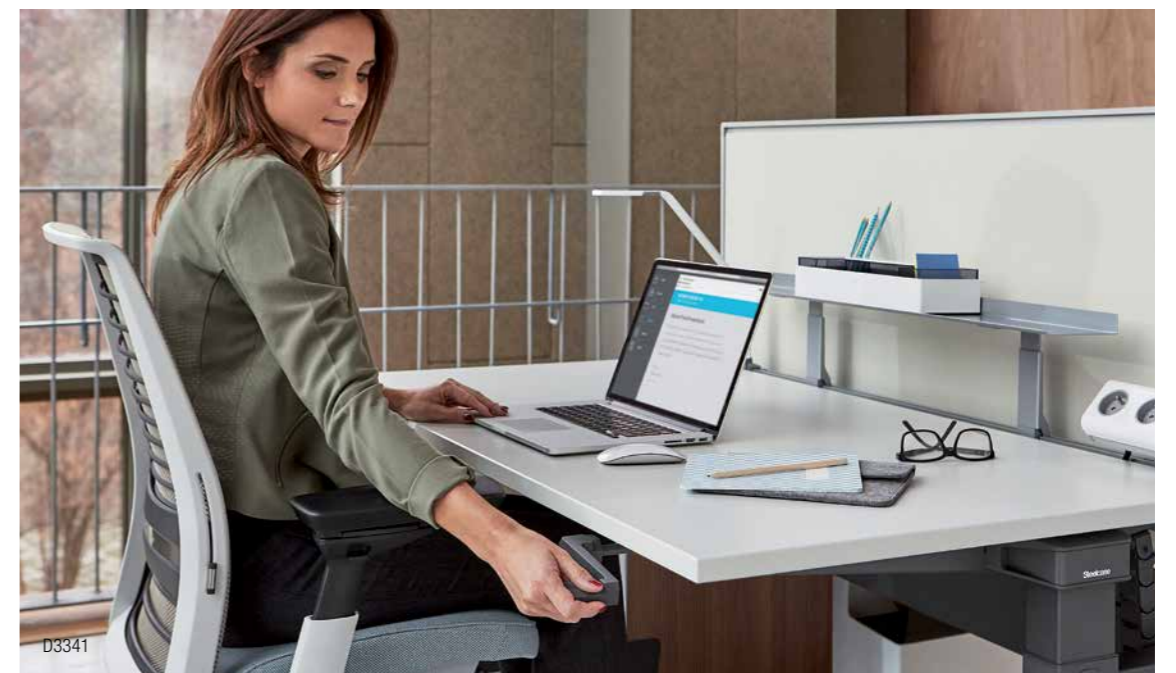

ANTIMICROBIAL SURFACES

Ology desks offer the option of an antimicrobial protection on the most frequently touched desk surfaces: the power access door, height adjustment controls, and the worksurface area closest to the user.

POWERFUL PROTECTION

BactiBlock® technology uses ionic silver, a naturally occurring element, to inhibit the growth of bacteria, mold, fungus and other microorganisms. This also makes it a powerful tool against odors and stains.



Ergonomics tailored to individual needs

Different work modes and workstyles require different ergonomic support, and Ology responds appropriately. Integrated rail supports adjustable monitor arms, lighting, and worktools. Screens add privacy. Power and data are easily within reach. Wide ranging choices make it easy to provide precise ergonomic comfort and support with Ology.

7.6 MILLION

work days lost in one year due to work-related back pain and other musculoskeletal disorders.

Source: National Health Service, U.K., reporting in 2012 for 2010-2011.



D0049 | OLOGY DESK FIXED HEIGHT (SN), DIVISIO (AT14), PARTITO SCREEN (DB19)



SOFT EDGE

significantly reduces unhealthy pressure on forearms and reduces shoulder and neck fatigue.

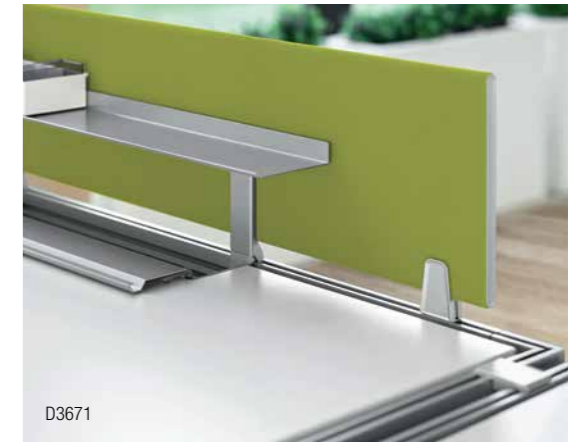

INTEGRATED RAIL

supports worktools, monitor arms and lighting to expand the workspace, reduce clutter, and increase productivity.



POWER ACCESS DOOR

puts outlets within easy reach.



SLIDING TOP

provides easy access to power.

Extending wellbeing throughout the workplace

Ology offers many possibilities for different zones within the workplace, supported by benching or desking solutions. Ology provides solutions for resident and nomadic zones, whether open or enclosed spaces.

Choose from height adjustable worksurfaces in a wide array of shapes and sizes, a fixed height

version, plus a wide array of technology support, worktools, lighting, and privacy components that integrate seamlessly with Ology. Now every part of the office can support health and wellbeing.

CAD files and symbols for Ology settings are available at www.steelcase.eu



D3344 | OLOGY BENCH TELESCOPIC (B7/CH), PARTITO SCREEN (AT02), GESTURE TASK CHAIR (TR14)

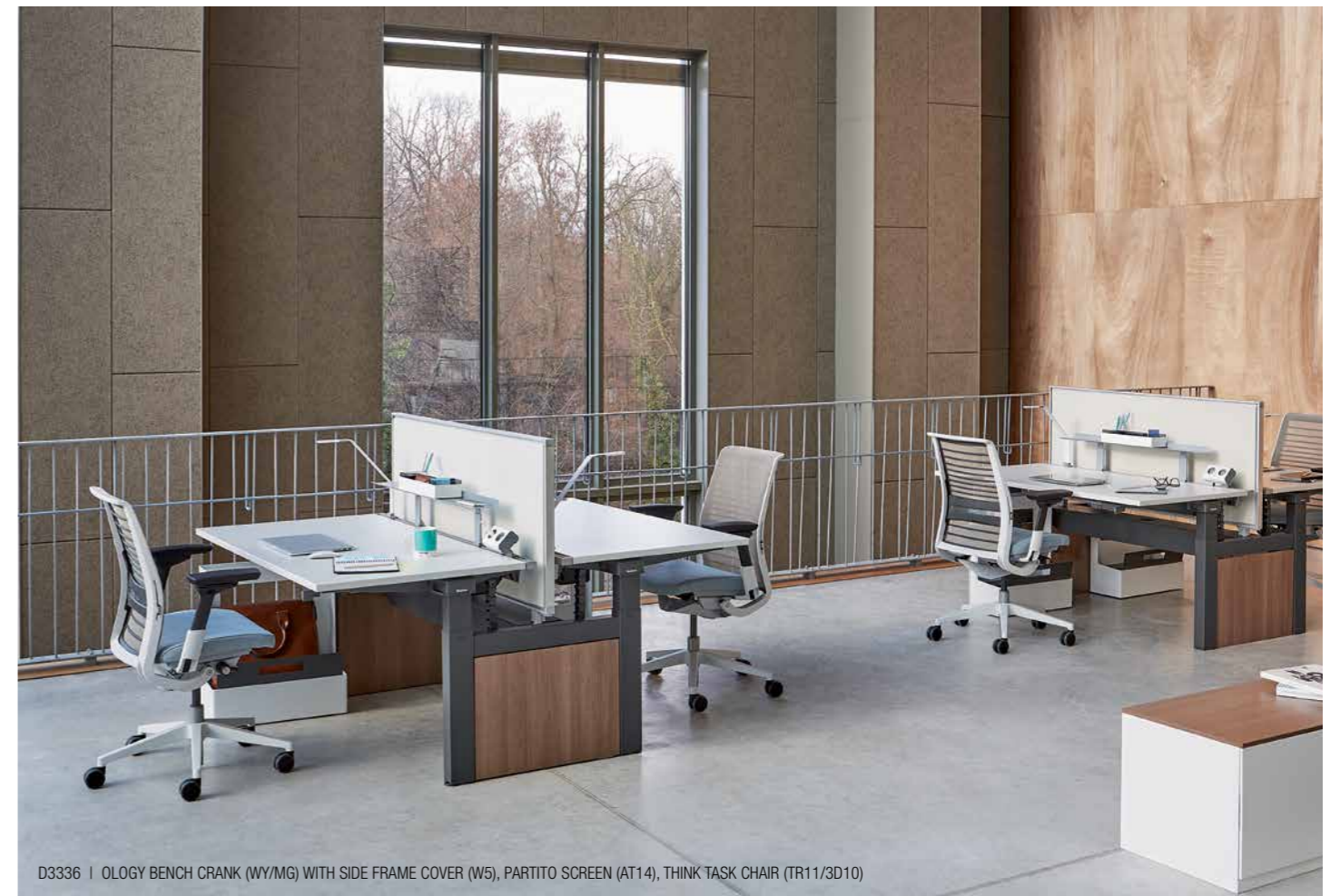

D3336 | OLOGY BENCH CRANK (WY/MG) WITH SIDE FRAME COVER (W5), PARTITO SCREEN (AT14), THINK TASK CHAIR (TR11/3D10)

RESIDENT ZONES



D0350



D0351

NOMADIC ZONES



D0348



D0349

LOGY OVERVIEW

DESK

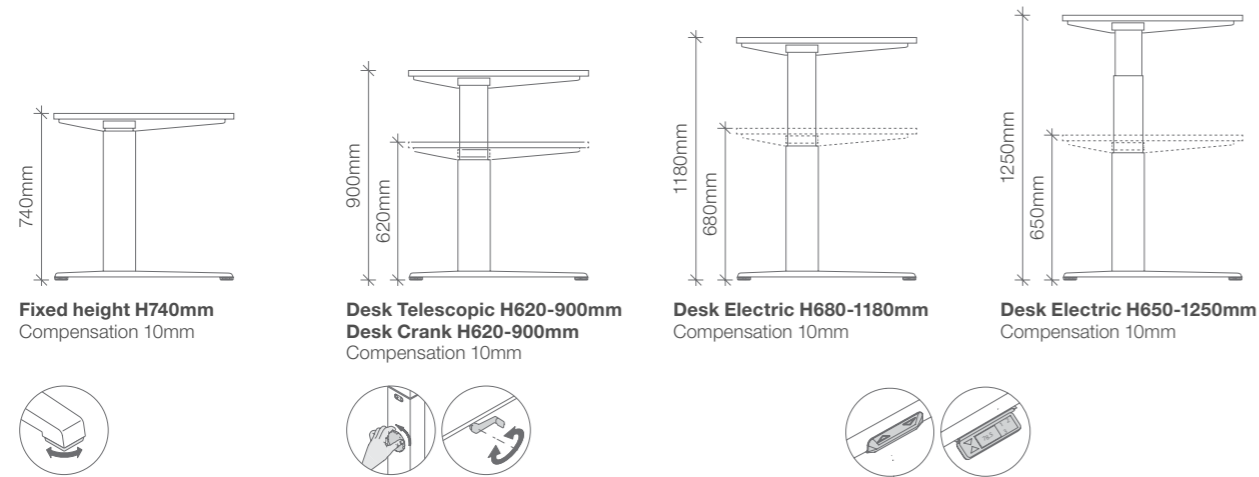

BENCH

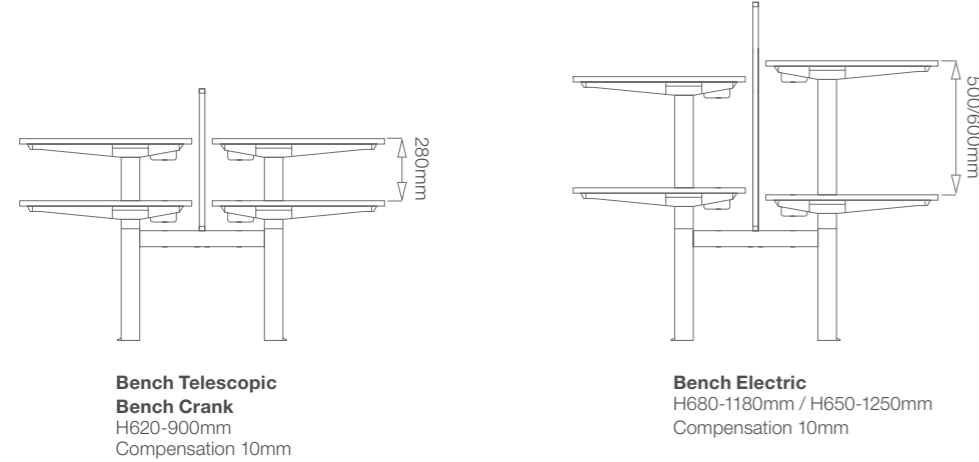

SURFACE MATERIALS

DECOR - WOOD

- AK Clear Oak
- AT Acacia*
- B7 Seagull
- SN Walnut Natural
- W5 Walnut
- WY Snow*

FABRICS (SCREENS)

- AT02 Grey
- AT03 Apple Green
- AT05 Orange
- AT14 Coconut
- AT17 Nickel
- 2007 Petrol
- 2053 Chili Pepper

PAINT

- CH Champagne
- MG Merle
- SL Platinum metallic
- WM Artic White Mat
- ZW Pearl snow

Colours are representative and may vary slightly from actual material.
These are color options shown in the brochure.
* with Seamless Edge option

SUSTAINABILITY

DESIGNING FOR THE ENVIRONMENT REQUIRES INNOVATIVE THINKING AND SOLUTIONS.

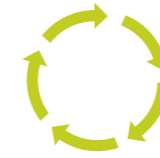

LIFE CYCLE

During our product development process we consider each stage of the life cycle: from materials extraction, production, transport, use and reuse, until the end of its life.

Thanks to the Life Cycle Assessment (LCA) method, Steelcase quantified Ology environmental impacts to set the stage for further improvements.

This method, based on ISO 14040 and 14044 and selected by The European Union for environmental evaluation, allows us to quantify the environmental impact of our products throughout their whole lifecycle.

CERTIFICATIONS

To show continuous improvements, we communicate Ology environmental performance through voluntary environmental labels and declarations. Sustainability related actions and results are communicated in the annual Steelcase Corporate Responsibility report.

MATERIALS

Up to 50% recycled materials, by weight (30% pre-consumer + 20% post-consumer).

Wood from European sustainably managed forests.

Materials chemistry assessment throughout their lifecycle.

100% recycled cardboard.

PRODUCTION

Made by Steelcase in Madrid (SP) and Rosenheim (DE).

TRANSPORT

Made in Europe, close to customers.

Optimised packaging to keep transport volumes as low as possible and improve filling rates.

USE

Designed for a long product life, with replaceable parts.

Materials meet stringent health and indoor air quality criteria.

Maintenance information available upon request.

END OF LIFE

99% theoretically recyclable by weight.

100% theoretically recyclable cardboard and LDPE film for packaging.

Quick and easy disassembly.

Plastic parts clearly labelled for easy sorting and effective recycling.

Designed to encourage responsible end of use strategies - refurbishing, charitable donation or recycling.

PRODUCT

EPD EPD - Environmental Product Declaration

PEP PEP - Product Environmental Profile

NF NF Environnement

OFFICE EXCELLENCE CERTIFIE NF Office Excellence Certifié

Blauer Engel

SCS Certified Indoor Air Quality Performance

Cradle-to-Cradle (Bronze)

MATERIALS

PEFC PEFC - Programme for the Endorsement of Forest Certification

E1 E1 - Low concentration of formaldehyde in wood

PLANTS

ISO 14001 ISO 14001 - Environmental management system

EMAS EMAS - European Eco-Management and Audit Scheme

OHSAS 18001 OHSAS - Occupational Health and Safety Assessment Series

FIND OUT MORE

Visit steelcase.eu to discover more about Steelcase's unique ecodesign strategy.

Steelcase®

Visit steelcase.com



facebook.com/Steelcase



twitter.com/Steelcase



youtube.com/SteelcaseTV

Concept and Design / Steelcase
16-E0000044 06/16 © 2016 Steelcase Inc. All rights reserved. All specifications subject to change without notice.
Printed on at least 60% recycled paper. Cert no. BV-COC-858659. Printed in France by OTT Imprimeurs – Wasselonne.

